

FLA/FLC/FLDseries

HEAVY DUTY CNC FLAT BED LATHE



FORCE ONE MACHINERY CO.,LTD.

No.5,Ln. 272,Dalin Rd.,Daya Dist. Taichung City 428,Taiwan

Tel: +886-4-2560 2500 Fax: +886-4-2560 2400

E-mail: sales@forceonecnc.com <http://www.forceonecnc.com>

First edition third print 07 . Aug . 2024

FLA/FLC/FLD series

HEAVY DUTY CNC FLAT BED LATHE



FLD Series: Bed width / Auxiliary guide **700 / 850** mm



FLC Series: Bed width Auxiliary guide **560 / 710** mm

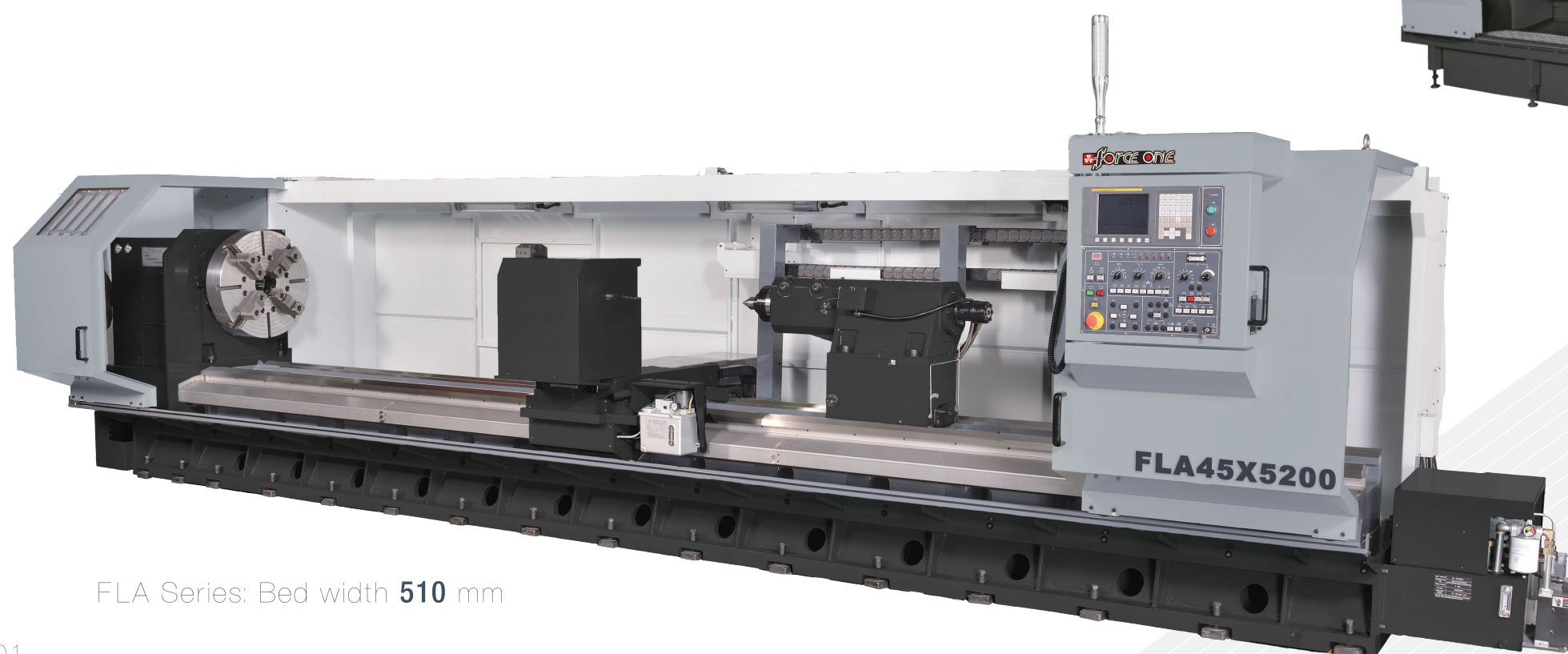

FLA Series: Bed width **510** mm

FEATURES

- Hydraulic tailstock with rotating quill for higher rigidity support.
- Solid box-construction casting headstock
- Spindle speed ranges are auto changed by M code
- Infinitely variable speeds are commanded by S code
- Three (3) "V" bed ways for better rigidity
- Full power output at low spindle speed
- High torque (166 times of spindle motor torque)

WORKING RANGE

FLA

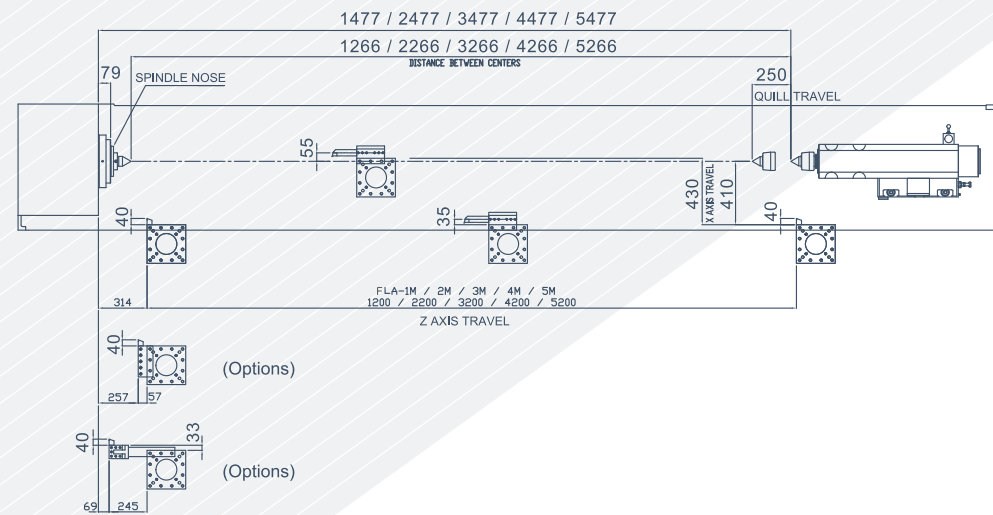

FLC/FLD

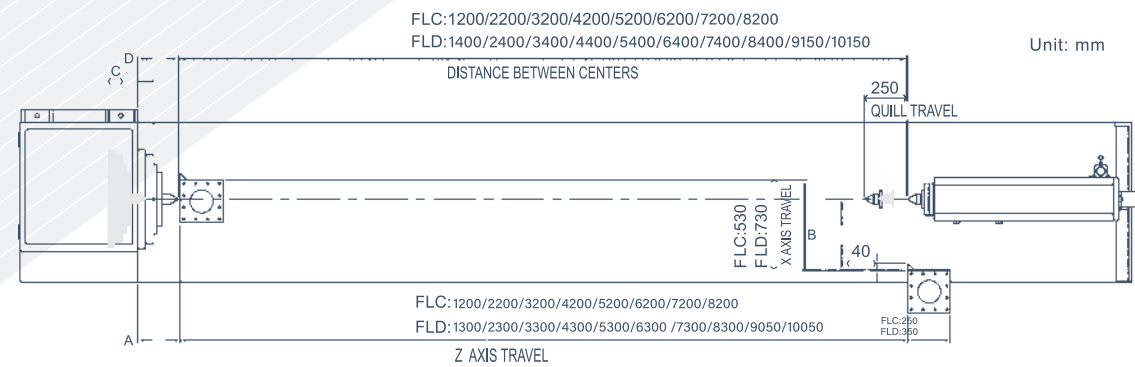

FLC	C	D	FLD	C	D	FLC	A	B	FLD	A	B
6"	96	243	6"	81	227	30	250	518	45	260	721
9"	87	228	9"	82	222	45	170	518	60		
12"	93	241	12"	88	235	40	170	540			

DIMENSION

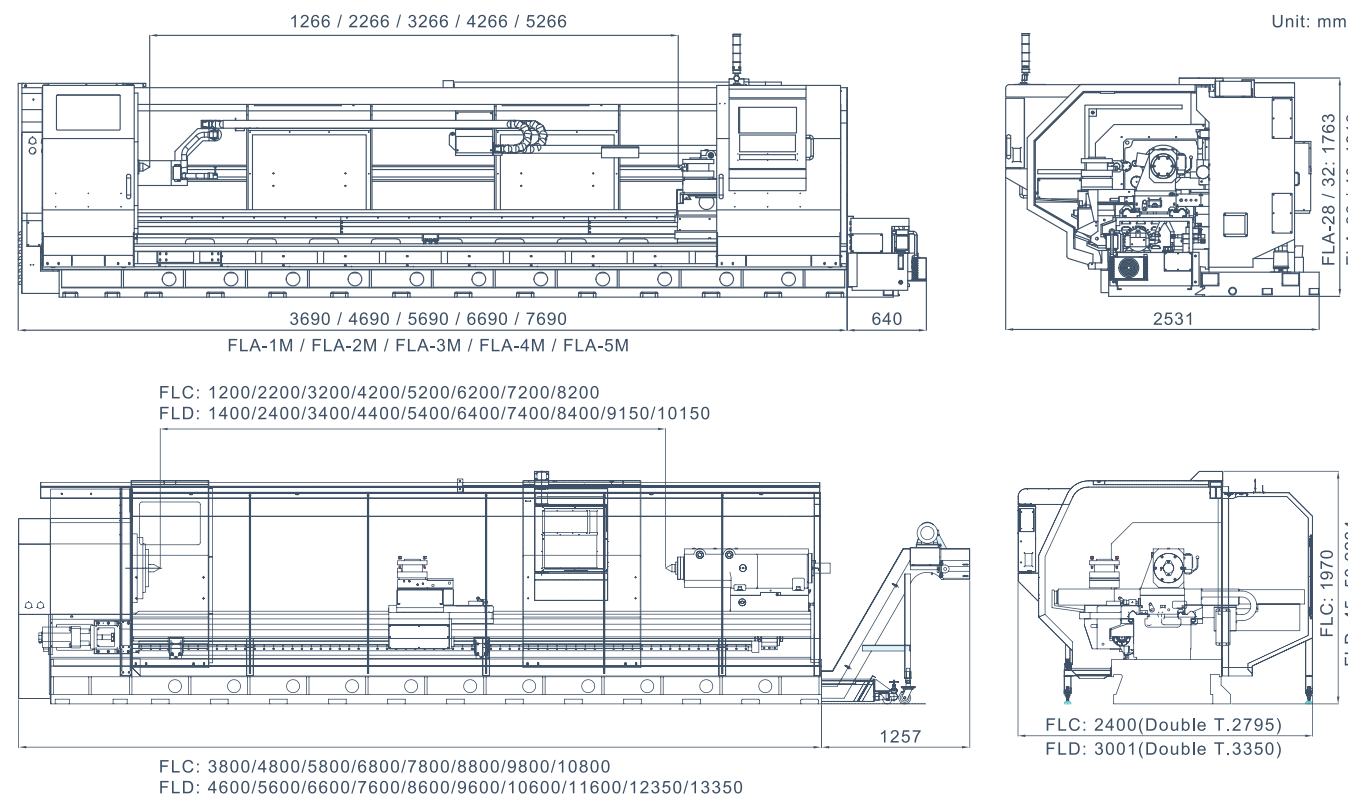

SPINDLE TORQUE

FANUC α i18

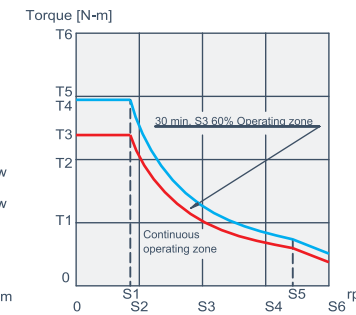
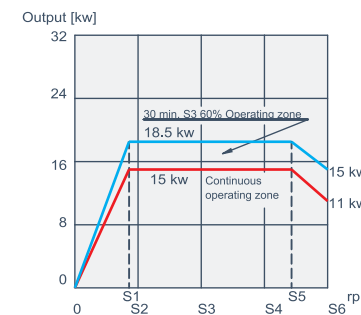

FLA	speed [min ⁻¹]						Torque [N-m]					
	S1	S2	S3	S4	S5	S6	T1	T2	T3	T4	T5	T6
Motor	1500	1750	3500	5250	6000	7000	40	80	95.5	117.78	120	160
Spindle M41 i=0.0197	30	34	69	103	118	138	2029	4059	4845.3	5975.6	6088	8118
Spindle M42 i=0.0514	77	90	180	270	308	360	779	1557	1859	2292.7	2336	3115
Spindle M43 i=0.0954	143	167	334	501	572	668	419	839	1001.1	1234.6	1258	1677
Spindle M44 i=0.2486	373	435	870	1305	1492	1740	161	322	384.1	473.7	483	644

FANUC

α i18 / 7000 motor

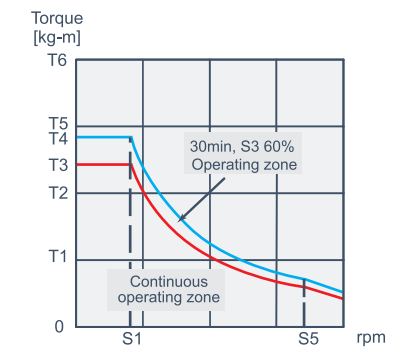
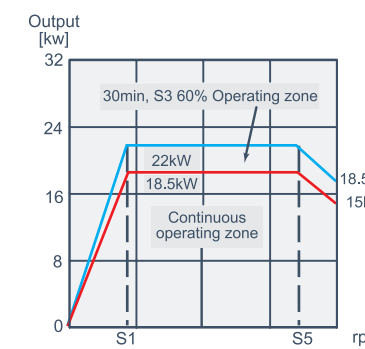

FLC	Speed [rpm]						Torque [kg-m]					
	S1	S2	S3	S4	S5	S6	T1	T2	T3	T4	T5	T6
Motor	1500	1750	3500	5250	6000	7000	5	10	12.01	14.29	15	20
Spindle M41 i = 0.0075	11	13	26	39	45	53	667	1333	1601	1904	2000	2667
Spindle M42 i = 0.0165	25	29	58	87	99	116	303	606	728	865	909	1212
Spindle M43 i = 0.045	68	79	158	236	270	315	111	222	266	317	333	444
Spindle M44 i = 0.1005	151	176	352	528	603	704	50	100	119	142	150	200

FANUC α i22

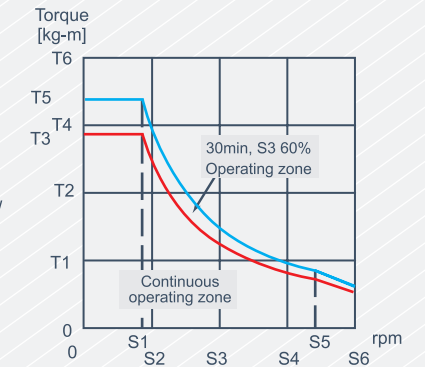
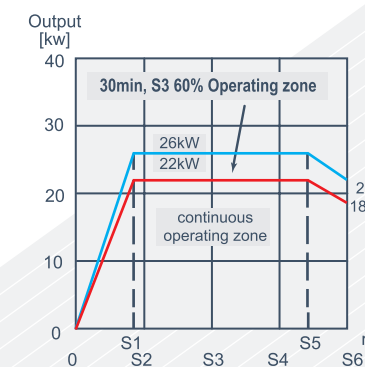

FLD	Speed [rpm]						Torque [kg-m]					
	S1	S2	S3	S4	S5	S6	T1	T2	T3	T4	T5	T6
Motor	1500	1750	3500	5250	6000	7000	5	10	14.3	15	16.9	20
Spindle M41 i = 0.006	9	11	21	32	36	42	833	1667	2380	2500	2813	3333
Spindle M42 i = 0.0155	23	27	54	81	93	109	323	645	921	968	1089	1290
Spindle M43 i = 0.0375	56	66	131	197	225	263	133	267	380	400	450	533
Spindle M44 i = 0.0975	146	171	341	512	585	683	51	103	146	154	173	205

OPTIONS

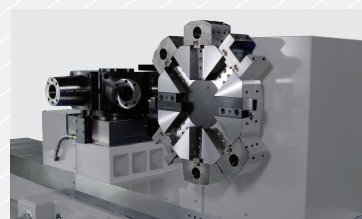

DOUBLE TURRETS



ROLLER SUPPORT BRACKET

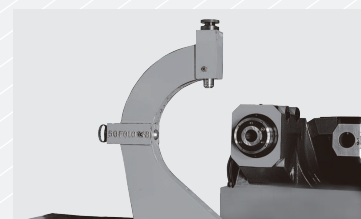

FOLLOW REST (3 V BED WAY)



C AXIS GEAR SYSTEM WITH REDUCER

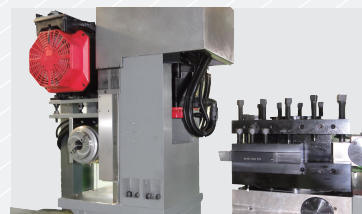

Y AXIS & MILLING DEVICE

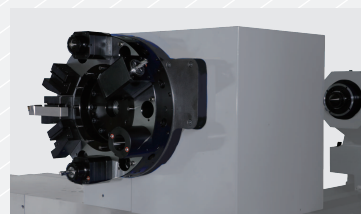

DRIVING TOOL TURRET

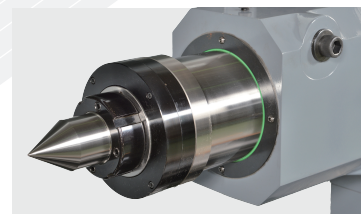

ROTATE QUILL TAILSTOCK
The higher rigidity rotate quill type tailstock has bigger bearings than live center.

SPECIFICATIONS

MODEL	ITEM	FLA-32	FLA-40	FLA-45
Capacity	Swing over bed	820 mm (32.3")	820 mm (32.3")	820 mm (32.3")
	Swing over cross slide	470 mm (18.5")	470 mm (18.5")	470 mm (18.5")
	Center height	420 mm (16.5")	420 mm (16.5")	420 mm (16.5")
	Distance between center	1200 mm (47.2"), 2200 mm (86.6"), 3200 mm (125.9"), 4200 mm (165.3"), 5200 mm (204.7")		
	Bed width	510 mm (20")		
Spindle	Spindle bore	A2-11 (4")	A2-11 (6")	A2-15 (9") only for 36/40
		L2: 30 ~ 90 rpm	L2: 30 ~ 90 rpm	L2: 30 ~ 90 rpm
		L1: 50 ~ 201 rpm	L1: 50 ~ 201 rpm	L1: 50 ~ 201 rpm
		H2: 156 ~ 624 rpm	H2: 156 ~ 624 rpm	H2: 156 ~ 624 rpm
	Spindle nose	H1: 347 ~ 1200 rpm	H1: 347 ~ 1200 rpm	H1: 347 ~ 1200 rpm
		H1: 347 ~ 1200 rpm	H1: 347 ~ 1200 rpm	H1: 347 ~ 1200 rpm
	Speed range			
	Spindle center	MT5 (OPT.: MT6)		
	Width of slide	380 mm (14.9")		
	Turret type	H4 or V8 Hydraulic		
Tool size	H4 32 X 32 or V8 32 x 32			
X axis travel	430 mm (16.9")			
Z axis travel	1200 mm (47"), 2200 mm (86"), 3200 mm (125"), 4200 mm (165"), 5200 mm (204")			
X axis rapid travel	6 M/min dia. 40 x P5			
Z axis rapid travel	6 m/min 1.2M ~ 3M dia. 50 x P10, 4M ~ 5M dia. 63 X P10			
Tailstock	Quill diameter	Static quill with dia. 160 mm (6.2"), OPT.: Rotating quill		
	Quill travel	230 mm (9")		
	Quill taper	MT6		
Motor	X axis servo motor	FANUC αiF8 1.6 kw		
	Z axis servo motor	1.2M ~ 3M FANUC αiF12 3.0 kW, 4M ~ 5M FANUC αiF22 4.0 kW		
	Spindle motor	FANUC αiI15 15/18.5 kW, OPT.: 18.5/22 kW, 22/26 kW		
	Coolant pump	0.845 kW		
	Hydraulic pump	2 kW		
Machine Weight	1200 mm center distance	7300 kgs	7900 kgs	8300 kgs
	Each extra 1000 mm weight	10000 kgs		

- All specification, design and characteristics shown on this catalogue are subject to change without prior notice.

SPECIFICATIONS

MODEL	ITEM	FLC-30	FLC-35	FLC-40	FLC-45	FLC-50	FLD-45	FLD-50	FLD-50	FLD-60	
Capacity	Swing over bed	770 mm (30")	895 mm (35")	1020 mm (40")	1145 mm (45")	1265 mm (50")	1135 mm (45")	1265 mm (50")	1395 mm (55")	1520 mm (60")	
	Swing over cross slide	350 mm (13.8")	480 mm (18.9")	610 mm (24")	735 mm (28.9")	870 mm (34.2")	720 mm (28.3")	850 mm (33.5")	980 mm (38.6")	1110 mm (43.7")	
	Center height	390 mm (15.3")	455 mm (18")	520 mm (20.5")	585 mm (23")	650 mm (25.6")	585 mm (23")	650 mm (25.6")	715 mm (28.1")	780 mm (30.7")	
	Distance between center	1200 (47.2") / 2200 (86.6") / 3200 (126") / 4200 (165.4") / 5200 (204.7") / 6200 (244.1") / 7200 (283.5") / 8200 mm (322.8")					1400 (55.12") / 2400 (94.5") / 3400 (132.8") / 4400 (173.23") / 5400 (212.6") / 6400 (252") / 7400 (291.34") / 8400 (330.7") / 9150 (360.24") / 10150 mm (399.6")				
	Bed width / Auxiliary guide	560 mm (22") / 710 mm (27.95")					700 mm (27.56") / 850 mm (33.5")				
Spindle	Spindle speeds	Spindle nose									
		A2-11 (6")		11 ~ 600 rpm (Opt.: 12 ~ 800 rpm)				9 ~ 600 rpm (Opt.: 12 ~ 800 rpm)			
		A2-15 (9")		11 ~ 450 rpm (Opt.: 12 ~ 600 rpm)				9 ~ 450 rpm (Opt.: 12 ~ 600 rpm)			
		A2-20 (12", 14.5")		11 ~ 400 rpm (12")		11 ~ 400 rpm (12") 11 ~ 300 rpm (14.5")		9 ~ 400 rpm (12") , 9 ~ 300 rpm (14.5")			
		A2-28 (16")									
	A2-28 (21")										
	Spindle center	MT6									
Width of cross slide	380 mm (15")					420 mm (16.5")					
Width of carriage	885 mm (34.8")					950 mm (37.4")					
Turret	Turret	H4 - 250 or V8 Hydraulic					H4 - 350 or V8 Hydraulic				
	Tool size	32 x 32 mm (1.25")					32 x 32 mm (1.25")				
	X axis travel	530 mm (20.9)		630 mm (24.8")			730 mm (28.7")				
	Z axis travel	1200 mm (47.2") ~ 8200 mm (322.8")					1~8M: 1300 mm (51.18") - 8300 mm (326.77") 9~10M: 9150 mm (360.24") - 10150 mm (399.6")				
	X axis rapid travel	6 m/min , dia. 40 mm x P5									
	Z axis rapid travel	6 m/min, 1M ~ 5M (Dia. 63 mm x P10) , 6M ~ 7M (Dia. 80 mm x P10) , 8M ~ 10M (Rack and Pinion Driver)									
Tailstock	Tailstock quill diameter	Dia. 185 mm (7.3") , Rotating quill, OPT.: dia. 250 mm (9.8") / 350 mm (13.7")									
	Tailstock quill travel	250 mm (9.84") , OPT.: 300 mm for tailstock quill diameter 350 mm									
	Tailstock center	MT6									
Motor	X axis servo motor	FANUC αiF22 4 kW									
	Z axis servo motor	1 ~ 4M FANUC αiF22 4 kW, 5 ~ 7M FANUC αiF22 4 kW (Gear box) 8 ~ 10M αiF40 6 kW (Rack and Pinion Driver)									
	Spindle motor	FANUC αiI18 18.5/22 kW (OPT.: 22/26 kW, 30/37 kW, 37/45 kW)					FANUC αiI22 22/26 kW (OPT.: 30/37 kW, 37/45 kW, 45/55 kW)				
	Lubricant pump motor	25W									
	Coolant pump motor	0.845 kW									
Hydraulic pump motor	2.25 kW										
Machine Weight	1000 mm center distance	10200 kgs	10600 kgs	11000 kgs	11400 kgs	11800 kgs	16400 kgs	17000 kgs	17600 kgs	18200 kgs	
	Each extra 1000 mm weight	1200 kgs					1500 kgs				

- All specification, design and characteristics shown on this catalogue are subject to change without prior notice.

STANDARD ACCESSORIES

- Fanuc control and motors
- 4" spindle bore
- Auto 4 steps spindle speed change
- H4 or V8 turret (32 x 32, dia. 50 mm)
- Auto coolant, hydraulic and lubrication system
- Splash guard
- Hydraulic tailstock with static quill MT6
- Heat exchanger
- Tailstock backward protection equipment
- Work light
- Tool box with tools

OPTIONAL ACCESSORIES

- Extra spindle bore and motor
- Spindle oil chiller
- Hydraulic / manual chuck
- C axis or Spindle 1 / 15 degree indexing
- Driving tool turret
- Steady rest
- Follow rest
- Special boring bar holder
- Higher coolant pressure
- Chip conveyor
- Hydraulic tailstock with rotating quill
- Tool presetter
- Grinding head
- CE mark
- Transformer